

- 2 way pressure compensated flow control valve with integral reverse check valve
- Subplate mounting
- Flow rate setting:
 - with adjustment knob
 - with adjustment knob and keylock
- For use in meter-in, meter-out or bleed-off applications
- External pilot closing of pressure compensator
- Installation dimensions to ISO 4401-03-02-0-94 and DIN 24 340-A6
- Subplates - see catalogue HA 0002

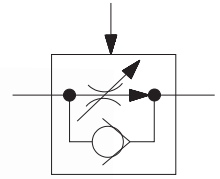

Functional Description

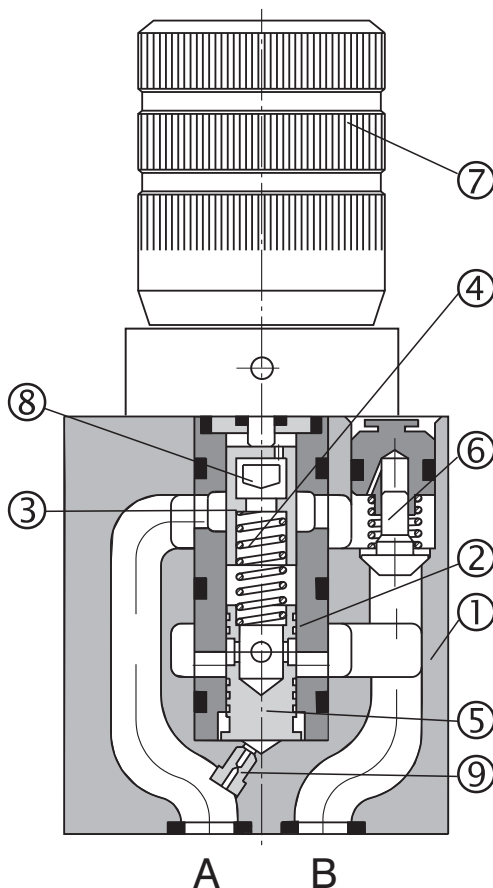

Pressure compensated flow control valves VSS2-062 are designed to provide adjustable controlled flow rates independent of changes in pressure and temperature.

They consist basically of housing (1), sleeve (2), throttling spool (3), spring (4), pressure compensator (5) and hand knob (7) with the respective setting mechanism.

The valve housing is phosphate coated.

Flow control valve VSS2-062-xxQ/Jx0-1

(without external pilot closing of pressure compensator)

Flow throttling in direction A → B takes place at the throttling area (8) which can be adjusted by hand knob (7). To ensure the flow rate stability in port B, a pressure compensator (5) is located behind the throttling area (8).

The spring (4) pushes both the throttling spool (3) and the pressure compensator (5) into their extreme positions, and provided that there is no flow through the valve, holds the pressure compensator open.

An introduction of flow to port A exposes inlet pressure through orifice (9) to the bottom area of the compensator spool and causes this spool to move in closing direction, thus decreasing the pressure difference at the throttling area (8). The movement of the compensator spool stops as a new equilibrium is reached. The pressure compensator compares continuously the pressure difference at the throttling area (8) with the amount preset by the spring preloading and accomplishes the required control, thus holding the flow rate constant.

Flow control valve VSS2-206-x/JxA-1
(with external pilot closing of pressure compensator)

This model functions on the same principle as the previous one. However, with this type of valve, the bottom surface area of the compensator is connected to an external port P via orifice (10), rather than being internally connected to port A. This arrangement enables external pilot closing of pressure compensator, which function can be described using the circuit diagram shown. When there is no flow through the valve (directional valve (11) in its middle position), pressure in port P acts at the bottom area of the compensator via orifice (10) and holds the compensator in its upper closed position. When the directional valve is shifted to its left position, the port A is connected to the system pressure, but the closed compensator avoids abrupt flow increase in port B. Hence, lunge of the actuator during start-up is prevented. The function of the compensator is the same, as the function described above. This model with external pilot closing of the compensator can only be used in meter-in circuits. Reverse free-flow from port B to port A, with both types of the flow control valves, is provided for by a built-in check valve (6).

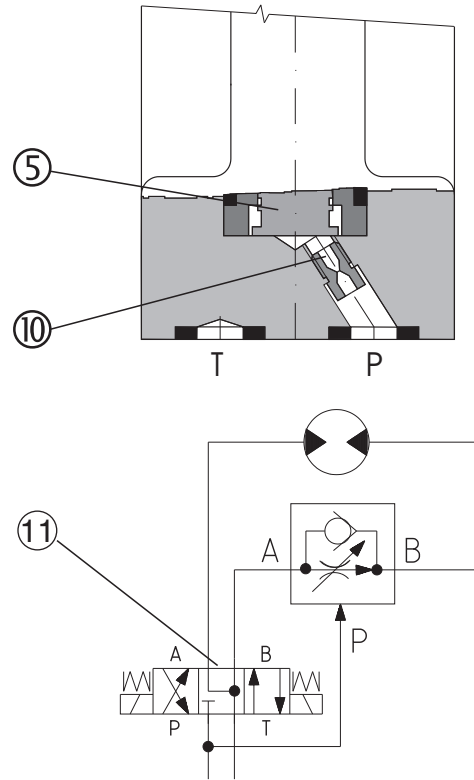

Ordering Code

VSS2-206- [] /J [] [] -1 []

Flow Control Valve

2 way design

Nominal size

Max. flow rate in L/min

| | |
|-----|------------|
| 0,6 | 0,6Q |
| 1,6 | 1,6Q |
| 3,2 | 3,2Q |
| 6,3 | 6Q |
| 16 | 16Q |
| 32 | 32Q |

Built-in check valve

no designation
V

Seals
NBR
FPM (Viton)

Design

Variant

- A with external pilot closing of the pressure compensator
- O** without external pilot closing of the pressure compensator

Adjustment

- Z hand knob with keylock
- O** hand knob without keylock

FOR PREFERRED TYPES SEE BOLD TYPING IN ORDERING CODE AND TABLE OF PREFERRED TYPES ON PAGE 3

Functional Symbols

Flow control valve: simplified

without external pilot

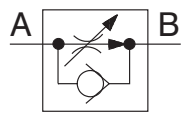

with external pilot

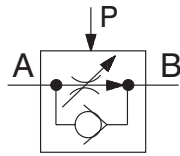

Flow control valve: detailed

without external pilot

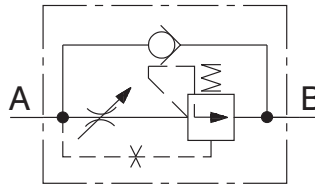

with external pilot

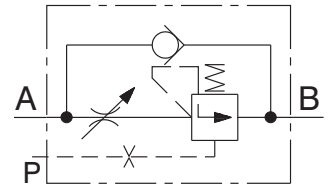

Technical Data

| | | | | | | | |
|--|----------------------|--|-----|-----|-----|----|-----|
| Nominal size | mm | 06 | | | | | |
| Maximum flow | L/min | 0,6 | 1,6 | 3,2 | 6,3 | 16 | 32 |
| Minimum flow | cm ³ /min | 10 | 15 | 20 | 25 | 60 | 250 |
| Maximum working pressure at port A | bar | 320 | | | | | |
| Maximum working pressure at port B | bar | 320 | | | | | |
| Pressure drop | bar | 8.5 ... 14 | | | | | |
| Hydraulic fluid | | Hydraulic oils of power classes (HL, HLP) to DIN 51524 | | | | | |
| Fluid temperature range for (NBR) | °C | -30 ... +100 | | | | | |
| Fluid temperature range for (Viton) | °C | -20 ... +120 | | | | | |
| Viscosity range | (mm ² /s) | 20 ... 400 | | | | | |
| Maximum degree of fluid contamination - for Q ≤ 1 L/min - for Q > 1 L/min | | Class 20/17/14 to ISO 4406 (1999) Class 21/18/15 to ISO 4406 (1999) | | | | | |
| Permissible flow rate variation for Q > 2.5 Q _{min} at pressure change 6 to 100% | % | ± 5 | | | | | |
| Weight | kg | 1.1 | | | | | |
| Mounting position | | optional | | | | | |

Spare Parts

Seal kit

| Type | Dimensions, quantity | | | Ordering number |
|--------------|----------------------------------|----------------------------|------------------------------|-----------------|
| | O-ring | Square ring | Back-up ring | |
| Standard NBR | 15 x 1.8 NBR70 (4 pcs.) | 9.25 x 1.68 NBR70 (4 pcs.) | 3.56 x 6.26 x 1.14 (1 pc.) | 521-0021 |
| | 9 x 1.8 NBR70 (1 pc.) | - | 8.31 x 11.01 x 1.14 (2 pcs.) | |
| | 4 x 1.75 (1 pc.) | - | 13.16 x 15.86 x 1.14 (1 pc.) | |
| | 12.42 x 1.78 (1 pc.) | - | 14.73 x 17.43 x 1.14 (1 pc.) | |
| Viton | 15 x 1.8 (4 pcs.) | - | 3.56 x 6.26 x 1.14 (1 pc.) | 521-0032 |
| | 9.25 x 1.78 90SH FPM SW (4 pcs.) | - | 8.31 x 11.01 x 1.14 (2 pcs.) | |
| | 4 x 1.75 (1 pc.) | - | 13.16 x 15.86 x 1.14 (1 pc.) | |
| | 12.42 x 1.78 (1 pc.) | - | 14.73 x 17.43 x 1.14 (1 pc.) | |
| | 9.25 x 1.78 FPM70 (1 pc.) | - | - | |

Preferred Types of Valves

| Type | Ordering Number |
|--------------------|-----------------|
| VSS2-206-06Q/JZO-1 | 521-0003 |
| VSS2-206-16Q/JZO-1 | 521-0004 |
| VSS2-206-32Q/JZO-1 | 521-0005 |

Characteristics

Measured at $v = 32 \text{ mm}^2/\text{s}$

Flow rate A → B dependent upon scale adjustment setting

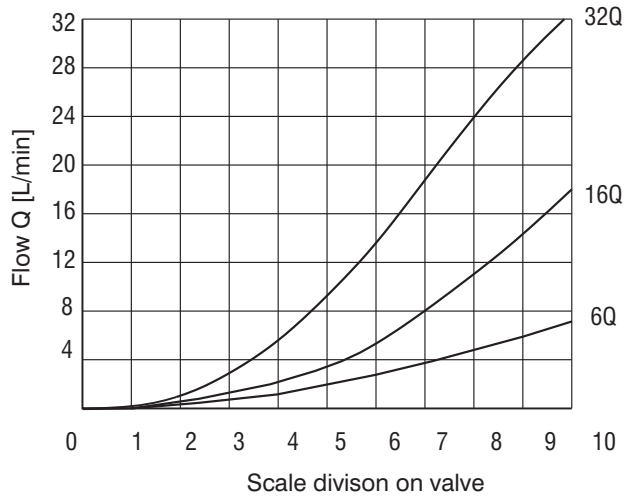
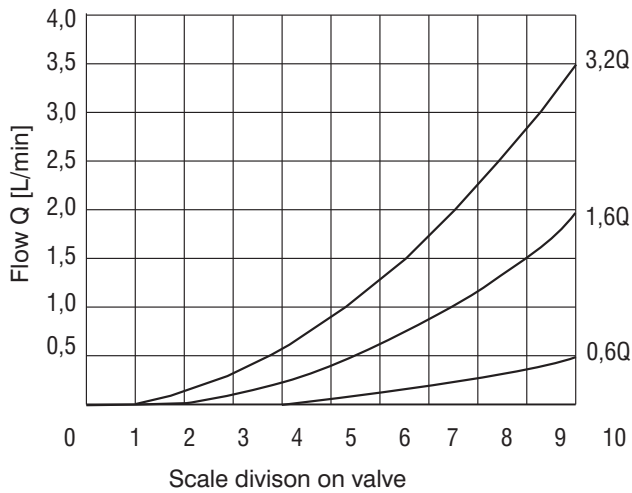

Δp -Q Characteristic

Measured at $v = 32 \text{ mm}^2/\text{s}$

Check valve

Pressure difference Δp related to flow from B → A

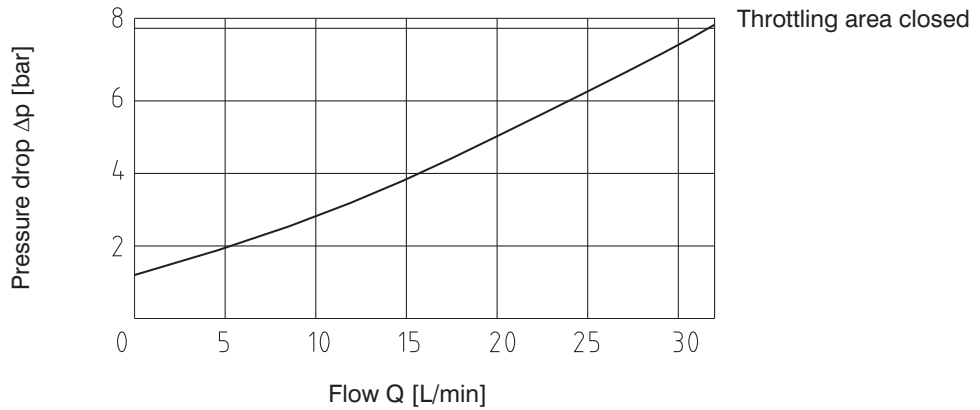

Dependency Flow-Temperature

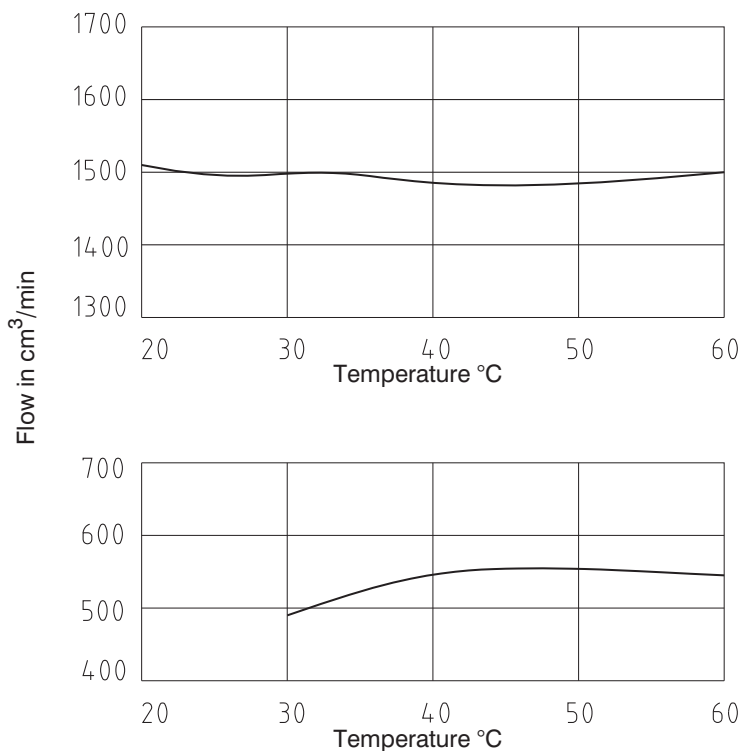

Characteristics $Q = f(p)$

Measured at $v = 32 \text{ mm}^2/\text{s}$

Flow rate dependent upon pressure

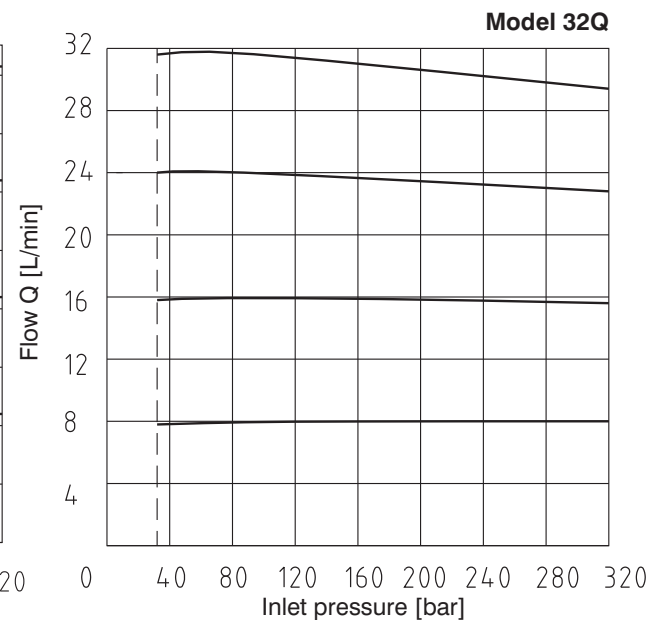
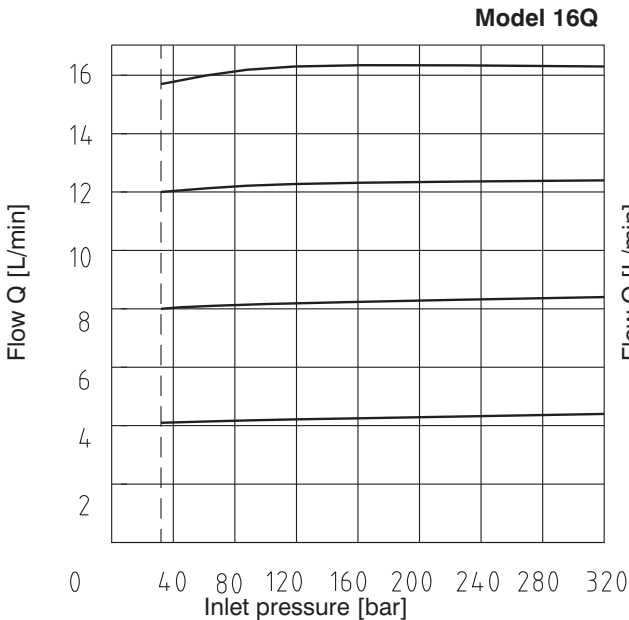
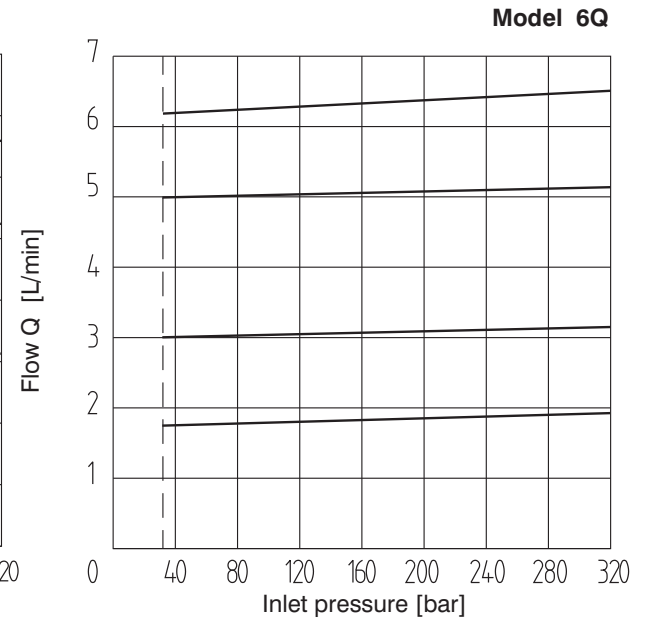
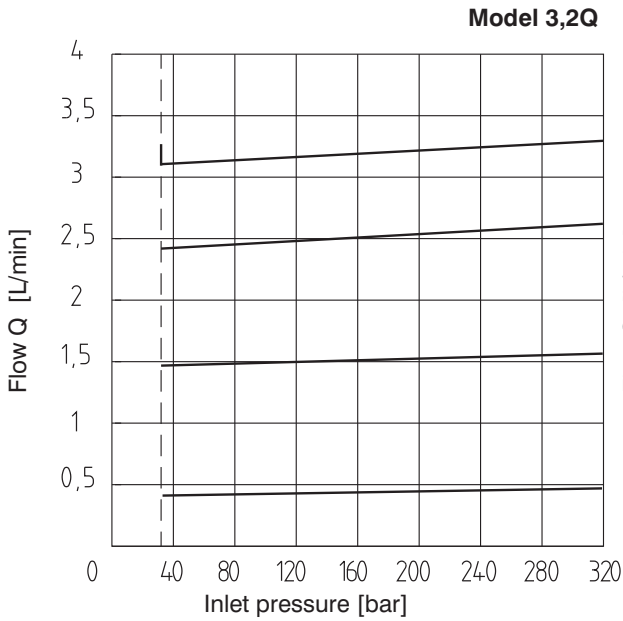
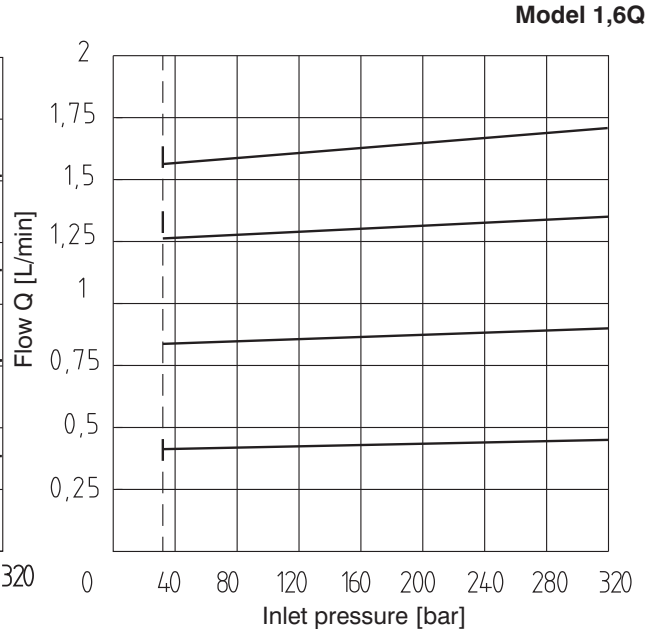
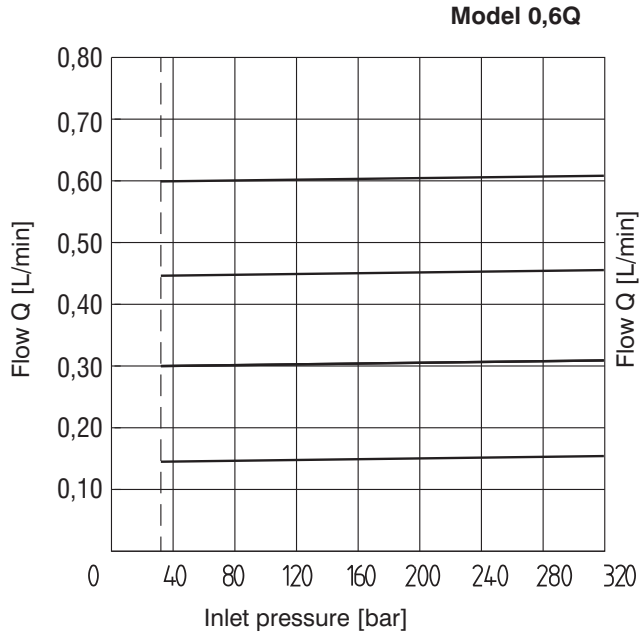

Valve Dimensions

Dimensions in millimeters

- 1 Port A (inlet)
- 2 Port B (outlet)
- 3 Port P (hole $\varnothing 5.2$ mm solely with type permitting external closing of the compensator, otherwise just the counterbore for O-ring)
- 4 Counterbore for O-ring (position for T port)
- 5 Name plate
- 6 Square ring 012 - KANTSEAL (4 pcs.) (9.25x1.68 NBR70)
- 7 Flow adjustment knob
- 8 Height of the valve with hand knob without keylock
- 9 Height of the valve with hand knob with keylock
- 10 Distance required to remove the key

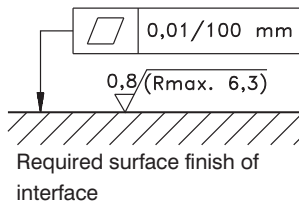
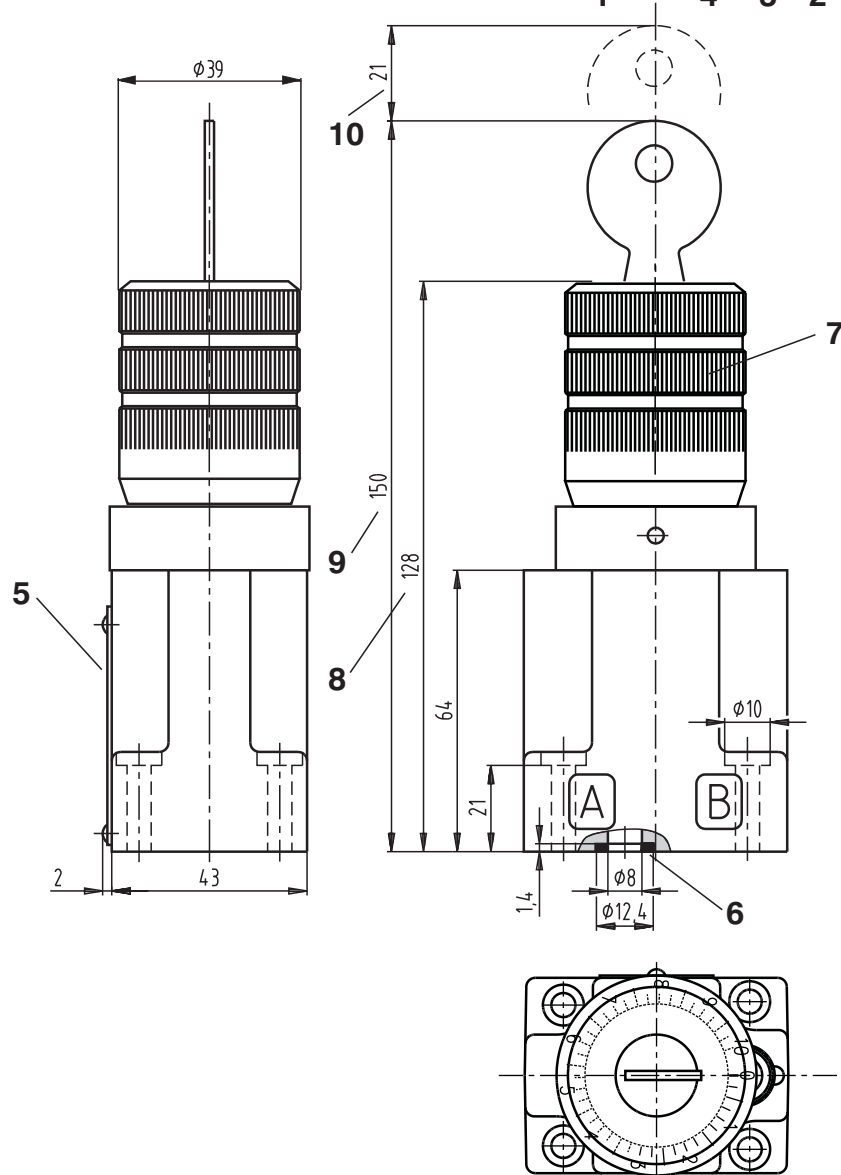
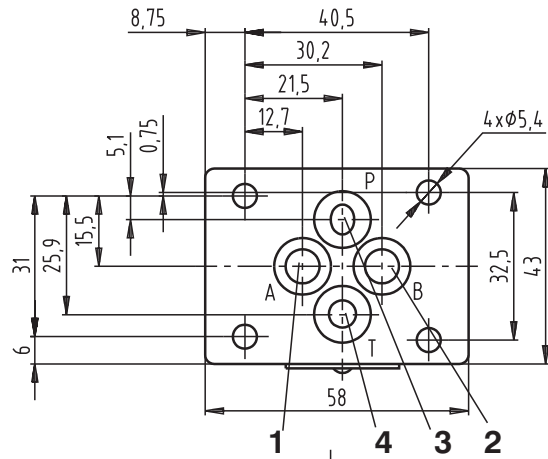

Caution!

- The packing foil is recyclable.
- Mounting bolts M5x30 DIN 912-10.9 (4 pcs.) must be ordered separately. Tightening torque of the bolts is 8.9 Nm.
- The technical information regarding the product presented in this catalogue is for descriptive purposes only. It should not be construed in any case as a guaranteed representation of the product properties in the sense of the law.

ARGO-HYTOS s.r.o. CZ - 543 15 Vrchlaví
 Tel.: +420-499-403111, Fax: +420-499-403421
 E-mail: sales.cz@argo-hytos.com
 www.argo-hytos.com