



## Off-line Filter Units

### FNA 045

- Operating pressure up to 4 bar
- Nominal flow rate up to 45 l/min
- For tank capacities up to 5000 l

## Description

### Application

In the off-line circuits of hydraulic and lubricating oil systems.

### Performance features

Protection

against wear: By means of filter elements that, meet even the highest demands regarding cleanliness classes and dirt-holding capacity.

Protection against

malfunction: By means of permanent filtration in the off-line circuits excellent cleanliness classes can be achieved. This can lead to significantly longer intervals between maintenance work and oil changes, as well as reducing machine failure due to contamination.

### Special design features

Cover: The fold-out handles at the cover facilitate opening. Because of the cover design the filter element can be changed almost without losing any oil. No pipes are needed except for the connection lines. The power units feature minimal noise output and low power consumption.

Pressure

relief valve: An integrated PRV (pressure relief valve) protects against overload.

Dirt

retention valve: Ensures that dirt accumulated in the filter is removed together with the element. Settled dirt cannot return into the system.

### Filter elements

Flow direction from centre to outside. The star-shaped pleating of the filter material results in:

- large filter surfaces
- low pressure drop
- high dirt-holding capacities
- long service life

### Filter maintenance

By using a clogging indicator the correct moment for maintenance is stated and guarantees the optimum utilization of the filter life.

### Materials

Pump and

filter housing: Aluminium alloy

Cover: Aluminium alloy

Seals: NBR (Viton on request)

Filter media: EXAPOR® - inorganic, multi-layer microfibre web

### Accessories

Water-absorbing filter elements (EXAPOR® AQUA) are available on request.

Electrical and optical clogging indicators are available on request – optionally with one or two switching points resp. temperature suppression. Dimensions and technical data see catalogue sheet 60.30.

## Characteristics

### Nominal flow rate

Up to 45 l/min at  $v = 35 \text{ mm}^2/\text{s}$   
(see Selection Chart, column 2)

### Connection

Threaded port according to ISO 228.  
Sizes see Selection Chart, columns 9 and 10

### Filter fineness

3  $\mu\text{m(c)}$  ... 5  $\mu\text{m(c)}$   
 $\beta$ -values according to ISO 16889  
(see Selection Chart, column 3 and diagram Dx)

### Dirt-holding capacity

Values in g test dust ISO MTD according to ISO 16889  
(see Selection Chart, column 5)

### Hydraulic fluids

Mineral oil and biodegradable fluids  
(HEES and HETG, see info-sheet 00.20)

### Temperature range of fluids

0 °C ... +65 °C (also see viscosity range)

### Ambient temperature range

0 °C ... +50 °C

### Viscosity range

Electro motor air cooled type of protection: IP 55	Continuous operation min.	Continuous operation max.	Short-term operation max.
3 ~ 400 V / 460 V	15 mm <sup>2</sup> /s	600 mm <sup>2</sup> /s*	800 mm <sup>2</sup> /s*
1 ~ 230 V	15 mm <sup>2</sup> /s	600 mm <sup>2</sup> /s*	800 mm <sup>2</sup> /s*

\* If the filter unit is operated together with the ARGO-HYTOS oil particle counter PODS, maximum viscosity in the "PODS" position is 400 mm<sup>2</sup>/s.

### Tank capacity

approx. 10 l

### Maximum suction height

1,5 m

### Operating pressure

Max. 4 bar, pressure protection with pressure relief valve;  
cracking pressure see Selection Chart, column 11

### Operating position

Vertical, pump block at the bottom

### Recommended tank capacities

From 500 l ... 5000 l  
Off-line filter units for smaller tank capacities  
see catalogue sheet 80.40.

# Diagrams

## Filter fineness curves in Selection Chart, column 3

**Dx**

Filtration ratio  $\beta$  as a function of particle size  $x$  obtained by the Multi-Pass-Test according to ISO 16889

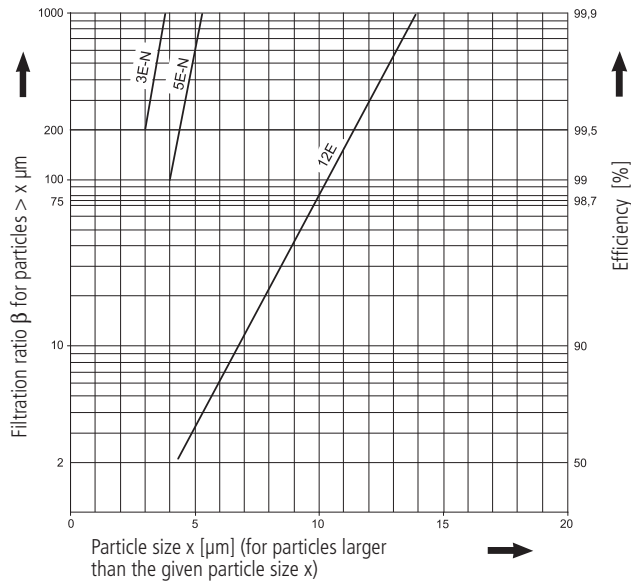

The abbreviations represent the following  $\beta$ -values resp. finenesses:

**For EXAPOR®-elements:**

**3 E-N** =  $\beta_{3(c)}$  = 200 EXAPOR®  
**5 E-N** =  $\beta_{5(c)}$  = 200 EXAPOR®  
**12 E** =  $\beta_{12(c)}$  = 200 EXAPOR®

For special applications, finenesses differing from these curves are also available by using special composed filter material.

# Selection Chart

Part No.	Nominal flow rate	Filter fineness, see Diag. <b>Dx</b>	Dirt-holding capacity	E-motor operating voltage	E-motor operating power	E-motor operating frequency (max.)	Engine speed at 50 Hz	Connection A Inlet	Connection B Outlet	Cracking pressure of by-pass	Symbols hydraulic	Symbols electric	Replacement filter element Part No.	Clogging indicator
1	2	3	4	5	6	7	8	9	10	11	12	13	14	15
	l/min		g	V	Hz	kW	min <sup>-1</sup>			bar				
FNA 045-1553	45	3 E-N	840	1 ~ 230 V	50 (60)	1,1	1500	G1¼	G1	4	1	3	V7.1560-103	optional
FNA 045-1153	45	5 E-N	840	1 ~ 230 V	50 (60)	1,1	1500	G1¼	G1	4	1	3	V7.1560-03	optional
FNA 045-4553	45	3 E-N	840	3 ~ 400 V/460 V	50 (60)	1,1	1500	G1¼	G1	4	1	1, 2	V7.1560-103	optional
FNA 045-4153	45	5 E-N	840	3 ~ 400 V/460 V	50 (60)	1,1	1500	G1¼	G1	4	1	1, 2	V7.1560-03	optional

Optical or electrical indicators are available to monitor the clogging condition of the element. If the indicator should be already mounted onto the filter head use the abbreviation "M" behind the part number of the indicator. The printed order acknowledgements show both items separately.

**Order example:** The filter FNA 045-1553 has to be supplied with optical clogging indicator - response pressure 2,0 bar.

**Order example:** FN 045-1553 / DG 042-01 M mounted

Part No. (Basic unit) \_\_\_\_\_ mounted

Clogging indicator \_\_\_\_\_

For the appropriate clogging indicators see catalogue sheet 60.30.

**Remarks:**

- If operating frequency increases, pump delivery will increase as well.
- The filter units listed in this chart are standard units. If modifications are required, e.g. with water-absorbing filter elements, we kindly ask for your request.

## Dimensions

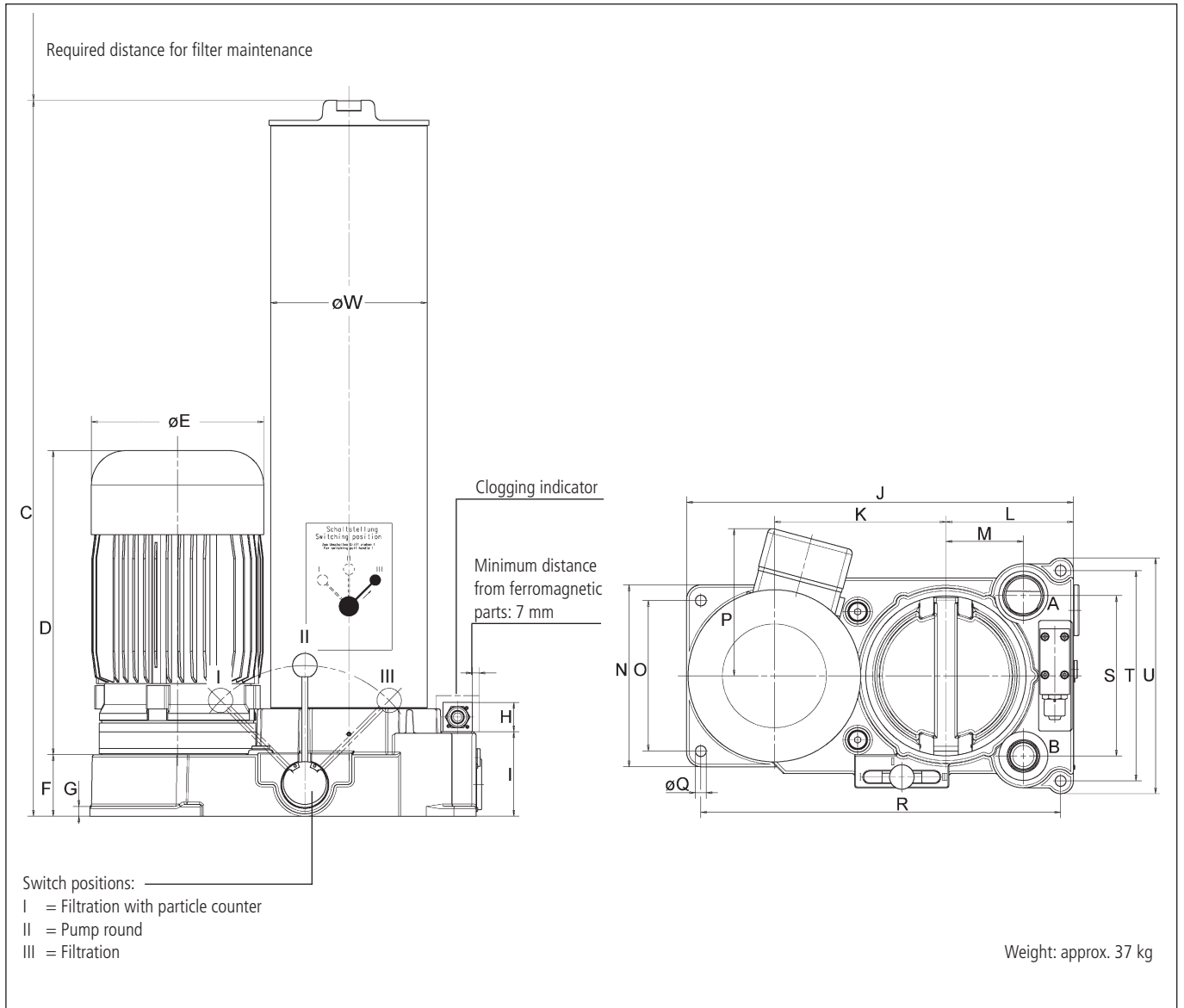

## Measurements

Type	A	B	C	D	E	F	G	H	I	J	K	L	M	N	O
FNA 045	G1¼	G 1	735	312	176	63	10	30	87	395+2	175	130	79±0,3	186+2	154±0,3
	P	Q	R		S		T		U		V	W			
FNA 045	150	11	367±0,3		164±0,3		215±0,3		241+2		700	160			

# Symbols

## Hydraulic:

1

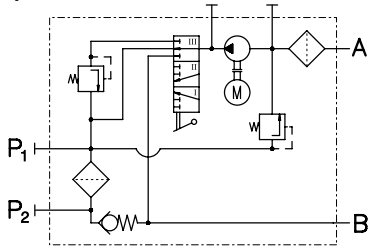

## Electric:

1

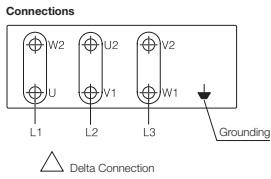

2

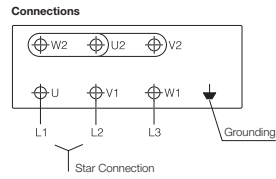

3

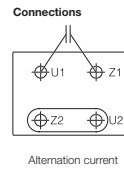

4

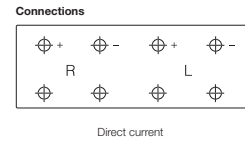

# Quality Assurance

## Quality management according to DIN EN ISO 9001

To ensure constant quality in production and operation, ARGO-HYTOS filter elements undergo strict controls and tests according to the following DIN and ISO standards:

- DIN ISO 2941** Verification of collapse/burst resistance
- DIN ISO 2943** Verification of material compatibility with fluids
- DIN ISO 3724** Verification of flow fatigue characteristics

- ISO 2942**
- ISO 3968**
- ISO 16889**

Verification of fabrication integrity (Bubble Point Test)  
Evaluation of pressure drop versus flow characteristics  
Multi-Pass-Test (evaluation of filter fineness and dirt-holding capacity)

Various quality controls during the production process guarantee the leakfree function and solidity of our filters.

Our engineers will be glad to advice you in questions concerning filter application, selection as well as the cleanliness class of the filtered medium attainable under practical operating conditions.

Illustrations may sometimes differ from the original. ARGO-HYTOS is not responsible for any unintentional mistake in this specification sheet.



**We produce fluid power solutions**

ARGO-HYTOS GMBH · Industriestraße 9 · D-76703 Kraichtal

Tel: +49 7250 76-0 · Fax: +49 7250 76-199 · info.de@argo-hytos.com · www.argo-hytos.com