



Clogging Indicators

**DG 100 • DG 101 • DG 200
DG 813 • DG 815 • DG 902**

- For Return or Suction Filters
- Connection G $\frac{1}{4}$ resp. M12 x 1,5
- Response/Switching pressure up to 2,5 bar

Description

Application

Monitoring the contamination of suction resp. return filters.

General

Filter elements installed in hydraulic filters remove dirt from a hydraulic system and therefore become contaminated themselves. Free pores or spaces in the filter material are obstructed by dirt particles, which causes a continuous increase in the initial pressure loss.

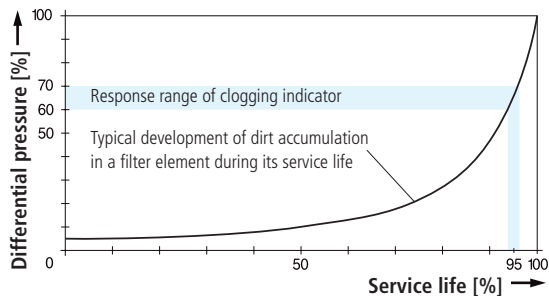

The dirt load collected in a filter element gradually increases during service, which also leads to a higher pressure drop. The resulting vacuum or back pressure is monitored by a clogging indicator. Once a preset value is reached, an electrical and/or optical signal is generated.

The following must be observed in this context:

The pressure drop caused by the filter element increases depending on the flow rate, the dirt load, and the viscosity of the pressure fluid. Therefore, a filter element is not regarded contaminated before the clogging indicator responds at operating temperature of the hydraulic system, causing a continuous signal.

Consequences of an overdue filter element change

Filters with

by-pass valve:

The more dirt has collected in the filter element, the more frequently the bypass valve opens and part of the hydraulic fluid remains unfiltered. The high pressure drop causes unnecessary power consumption.

Suction filters with-

out by-pass valve:

There is a high risk of pump cavitation with increasing vacuum caused by contaminated elements.

Characteristics

Operating pressure

- DG 100: - 1,0 ... + 0,25 bar
- DG 101: - 1,0 ... + 0,25 bar
- DG 902: - 0,5 ... + 1,0 bar
- DG 200: 0 ... + 10,0 bar
- DG 813: 0 ... + 10,0 bar
- DG 815: 0 ... + 10,0 bar

Connection

Threaded ports according to ISO 228 or DIN 13.

Sizes see Selection Chart, column 6 (other port threads on request)

Hydraulic fluids

Mineral oil and biodegradable fluids (HEES and HETG, see info-sheet 00.20)

Temperature range of fluids

- DG 100: - 30 °C ... + 100 °C (short term 120 °C)
- DG 101: - 30 °C ... + 100 °C (short term 120 °C)
- DG 902: - 15 °C ... + 100 °C (short term 130 °C)
- DG 200: - 20 °C ... + 90 °C
- DG 813: - 30 °C ... + 100 °C (short term 120 °C)
- DG 815: - 30 °C ... + 100 °C (short term 120 °C)

Ambient temperature range

- DG 100: - 30 °C ... + 80 °C
- DG 101: - 30 °C ... + 80 °C
- DG 902: - 30 °C ... + 80 °C*
- DG 200: - 20 °C ... + 90 °C
- DG 813: - 30 °C ... + 80 °C
- DG 815: - 30 °C ... + 80 °C

* Reduced switching accuracy in the temperature range - 30 °C ... - 15 °C owing to the principle of operation!

Materials

- DG 100: Housing steel, fitting brass, seal copper
- DG 101: Housing steel, fitting brass, seal copper
- DG 902: Housing brass, protection cap polyamide, diaphragm FPM, seal NBR
- DG 200: Housing polyamide, fitting brass, seal PTFE
- DG 813: Housing steel galvanized, protection cap NBR, diaphragm NBR, seal copper
- DG 815: Housing polyamide, fitting steel galvanized, diaphragm NBR, seal copper

Operating voltage

10 ... 30 V DC

(only required for clogging indicators with built-in LEDs)

Electrical service life

- DG 902: min. 106 switching cycles
- DG 813: min. 106 switching cycles
- DG 815: min. 107 switching cycles

Electrical protection

- DG 902: IP 44 (with protection cap)
- DG 813: IP 65 (with protection cap)
- DG 815: IP 65 (with mounted and secured socket)

Electrical connection

- DG 902: Flat plugs DIN 46247 - 6,3 x 1
Cable diameter approx. 6,5 mm
- DG 813: Flat plugs DIN 46244 - A 6,3 - 0,8
Cable diameter approx. 4 mm
- DG 815: Socket DIN 43650 - AF3
Cable diameter 6 ... 8 mm

Mounting position

No limitation

Overview of types

DG 100 / DG 101 - Manometer for Suction Filters



- Function: Manometer for optical monitoring of the dirt load in suction filters.
Green reading area = filter element O.K.,
Red reading area = filter element clogged.
- Option: Bottom-mounted fitting, making it possible to turn the manometer into the direction from which it is viewed, as compared to a fitting mounted on the back (standard).

DG 902 - Vacuum Switch for Suction Filters (change-over)



- Function: When the preset vacuum is reached, the built-in diaphragm switch changes over.
The change-over switch makes it possible to indicate a broken wire by means of a suitable electronic circuit, as compared to a make contact switch.

DG 200 - Manometer for Return Filters



- Function: Manometer for optical monitoring of the dirt load in return filters.
Green reading area = filter element O.K.,
Red reading area = filter element clogged.
In order to protect the measuring element from pressure peaks, the unit is provided with a built-in orifice system.
- Option: Bottom-mounted fitting, making it possible to turn the manometer into the direction from which it is viewed, as compared to a fitting mounted on the back (standard).

DG 813 - Pressure Switch for Return Filters (make/break)



- Function: The diaphragm switch closes resp. opens as soon as the pressure exceeds the preset value.
- Accessories: Suitable protection caps are available under part no. DG 813.0701 (central hole for cable \varnothing 1,5 up to 5 mm) and DG 813.0702 (2 holes for cable \varnothing 1,7 up to 2,2 mm).

DG 815 - Pressure Switch for Return Filters (change-over)



- Function: When the preset back pressure is reached, the built-in diaphragm switch changes over.
The change-over switch makes it possible to indicate a broken wire by means of a suitable electronic circuit, as compared to a make contact switch.
- Option: The transparent socket with 2 built-in LEDs makes it possible to have an additional optical indication of the element contamination.
When the operating voltage is switched on, a green LED lights up.
When the switching pressure is reached, a yellow LED lights up in addition.

Selection Chart

Part No.	Optical indicator	Electrical switch	Temp. suppression < +32° C	Response/Switching pressure	Type of contact	Switching voltage U	Switching current I	Switching power P	Symbol	Weight	Remarks
1	2	3	4	5 bar	6	7 V AC/DC	8 A AC/DC	9 VA/W AC/DC	10	11 kg	12
DG 100-00	•	-	-	-0,25	-	-	-	-	1	0,11	Fitting on the back
DG 101-04	•	-	-	-0,25	-	-	-	-	1	0,11	Bottom fitting
DG 902-11	-	•	-	-0,15	change-over	250/24	6,0/2,0	1500/48	2	0,13	with protection cap
DG 902-12	-	•	-	-0,25	change-over	250/24	6,0/2,0	1500/48	2	0,13	with protection cap
DG 200-05	•	-	-	+1,0	-	-	-	-	1	0,07	Fitting on the back
DG 200-11 ¹	•	-	-	+1,0	-	-	-	-	1	0,07	Fitting on the back
DG 200-06	•	-	-	+2,0	-	-	-	-	1	0,07	Fitting on the back
DG 200-15 ¹	•	-	-	+2,0	-	-	-	-	1	0,07	Fitting on the back
DG 200-16 ²	•	-	-	+2,0	-	-	-	-	1	0,07	Fitting on the back
DG 200-10	•	-	-	+2,0	-	-	-	-	1	0,07	Fitting on the back
DG 813-00	-	•	-	+1,2	make	42/42	4,0/4,0	100/100	3	0,07	without protection cap
DG 813-03	-	•	-	+1,5	make	42/42	4,0/4,0	100/100	3	0,07	without protection cap
DG 813-01	-	•	-	+2,0	make	42/42	4,0/4,0	100/100	3	0,07	without protection cap
DG 813-05	-	•	-	+2,5	make	42/42	4,0/4,0	100/100	3	0,07	without protection cap
DG 813-20	-	•	-	+1,2	break	42/42	4,0/4,0	100/100	4	0,07	without protection cap
DG 813-21	-	•	-	+2,0	break	42/42	4,0/4,0	100/100	4	0,07	without protection cap
DG 815-01	-	•	-	+1,2	change-over	250/30	4,0/4,0	250/60	5	0,13	-
DG 815-11	•	•	-	+1,2	change-over	-/30	-/0,25	-/3,0	6	0,13	-
DG 815-02	-	•	-	+2,0	change-over	250/30	4,0/4,0	250/60	5	0,13	-
DG 815-12	•	•	-	+2,0	change-over	-/30	-/0,25	-/3,0	6	0,13	-

Remarks:

- With return filters, the response/switching pressure of the clogging indicator used must be lower than the cracking pressure of the bypass valve, with suction filters it must be higher.
- The clogging indicators listed in this chart are standard units. Other designs available on request.

¹ for FR 043 / FR 072 (with preformed seals) ² for FNA 008/FNA 016 (as DG 200-06 but without throttle screw)

Dimensions

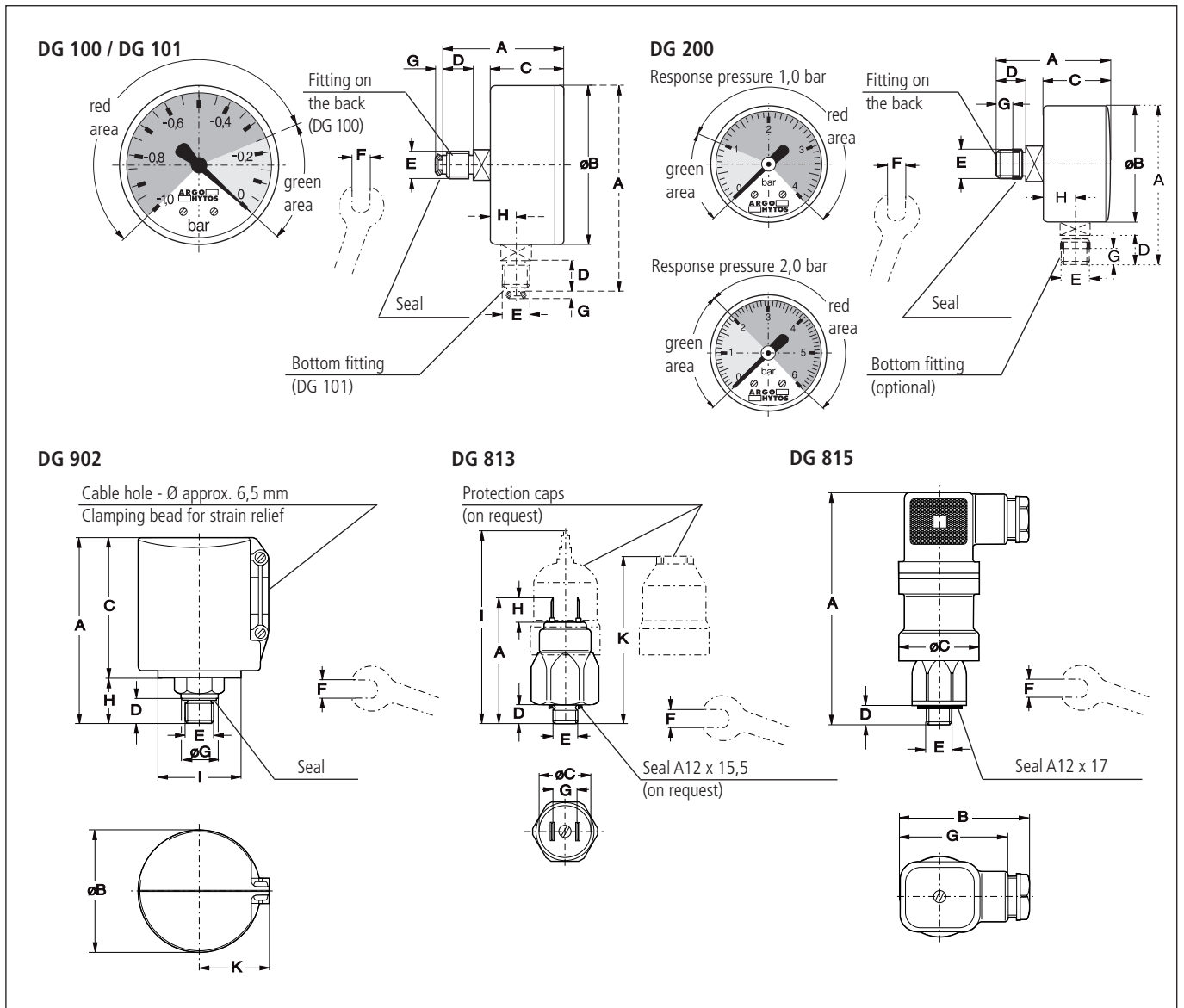

Measurements

Type	A	B	C	D	E	F	G	H	I	K
DG 100 / 101*	50 / 84*	64	30	13	G $\frac{1}{4}$	14	3,2	10*	-	-
DG 902	76	50	56	10	G $\frac{1}{4}$	21	18,5	20	34	30
DG 200	47 / 59*	41	26 / 24*	12	M12 x 1,5	14 / 12*	5	9*	-	-
DG 813	55	23,3	24	9	M12 x 1,5	24	13	9	88	74
DG 815	92	50	34	9	M12 x 1,5	27	40	-	-	-

* Bottom fitting

Symbols

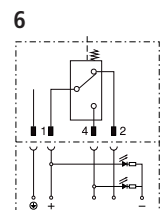
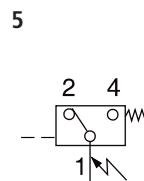
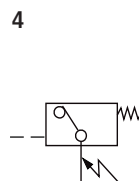
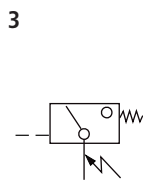
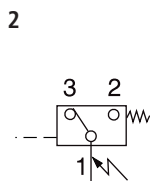
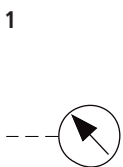

Spare Parts

DG 100
DG 101

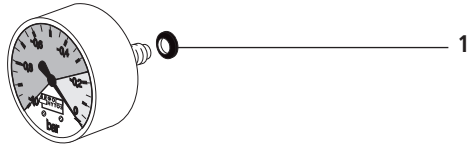

DG 902

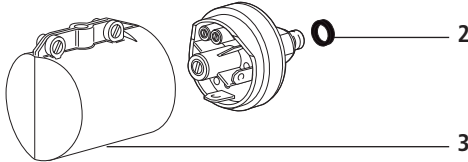

DG 813

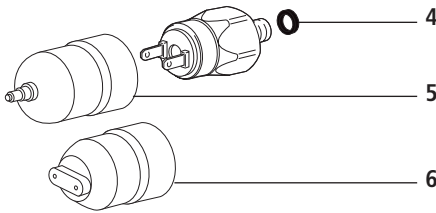

DG 815

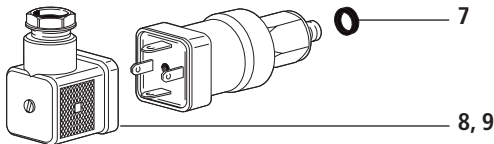

Pos.	Designation	Part No.
1	Seal	DG 100.0101
2	Seal	DG 902.0103
3	Protection cap	DG 902.1701
4	Seal * A12 x 15,5 DIN 7603-Cu	3331066
5	Protection cap *	DG 813.0701
6	Protection cap *	DG 813.0702
7	Seal A12 x 17 DIN 7603-Cu	3331069
8	Socket DIN 43650 - AF3	DG 041.1220
9	Socket with 2 LED DIN 43650 - AF3	DG 041.1200

*Not included in basic unit

The functions of the complete filters as well as the outstanding features of the filter elements assured by ARGO-HYTOS can only be guaranteed if original ARGO-HYTOS spare parts are used.

Quality Assurance

Quality management according to DIN EN ISO 9001

Various quality controls during the production process guarantee the leakfree function and solidity of our filters.

Our engineers will be glad to advise you in questions concerning filter application, selection as well as the cleanliness class of the filtered medium attainable under practical operating conditions.

Illustrations may sometimes differ from the original. ARGO-HYTOS is not responsible for any unintentional mistake in this specification sheet.



We produce fluid power solutions

ARGO-HYTOS GMBH · Industriestraße 9 · D-76703 Kraichtal

Tel: +49 7250 76-0 · Fax: +49 7250 76-199 · info.de@argo-hytos.com · www.argo-hytos.com