



Pressure Filters

D 042 • D 062

- In-line mounting
- Operating pressure up to 100 bar
- Nominal flow rate up to 70 l/min

Description

Application

In the pressure circuits of hydraulic and lubrication systems.

Performance features

Protection

against wear: By means of filter elements that, in full-flow filtration, meet even the highest demands regarding cleanliness classes.

Protection against malfunction: Through installation near to the control valves or other expensive components. The specific determined flow rate guarantees a closed by-pass valve even at $v \leq 200 \text{ mm}^2/\text{s}$ (cold start condition).

Filter elements

Flow direction from outside to centre. The star-shaped pleating of the filter material results in:

- large filter surfaces
- low pressure drop
- high dirt-holding capacities
- long service life

Filter maintenance

By using a clogging indicator the correct moment for maintenance is stated and guarantees the optimum utilization of the filter life.

Materials

Filter head: Aluminium alloy
Filter bowl: Aluminium alloy
Seals: NBR (Viton on request)
Filter media: EXAPOR®MAX - inorganic multi-layer microfibre web
Paper - cellulose web, impregnated with resin

Accessories

Electrical and/or optical clogging indicators are available - optionally with one or two switching points resp. temperature suppression.
Dimensions and technical data see catalogue sheet 60.30.

Characteristics

Operating pressure

0 ... 63 bar, min. 10^7 pressure cycles
Nominal pressure according to DIN 24550

0 ... 100 bar, min. 10^4 pressure cycles
Quasi-static operating pressure

Permissible pressures for other numbers of cycles

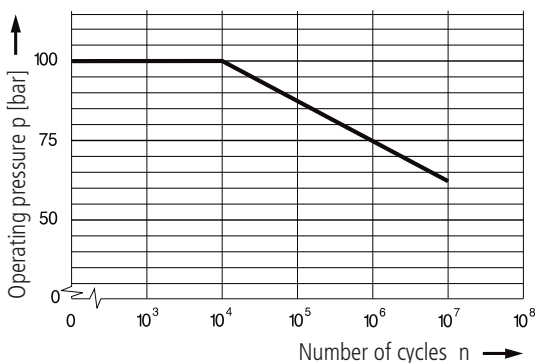

Nominal flow rate

Up to 70 l/min (see Selection Chart, column 2)
The nominal flow rates indicated by ARGO-HYTOS are based on the following features:

- closed by-pass valve at $v \leq 200 \text{ mm}^2/\text{s}$
- element service life > 1000 operating hours at an average fluid contamination of 0,07 g per l/min flow volume
- flow velocity in the connection lines:
 - up to 40 bar $\leq 4,5 \text{ m/s}$
 - up to 250 bar $\leq 8 \text{ m/s}$

Filter fineness

5 $\mu\text{m(c)}$... 30 $\mu\text{m(c)}$
 β -values according to ISO 16889
(see Selection Chart, column 4 and diagram Dx)

Dirt-holding capacity

Values in g test dust ISO MTD according to ISO 16889
(see Selection Chart, column 5)

Hydraulic fluids

Mineral oil and biodegradable fluids
(HEES or HETG, see info-sheet 00.20)

Temperature range

- 30 °C ... + 100 °C (temporary - 40 °C ... + 120 °C)

Viscosity at nominal flow rate

- at operating temperature: $v < 60 \text{ mm}^2/\text{s}$
- as starting viscosity: $v_{\text{max}} = 1200 \text{ mm}^2/\text{s}$
- at initial operation: The recommended starting viscosity can be read from the diagram D (pressure drop as a function of the kinematic viscosity) as follows: Find the 70% Δp of the cracking pressure of the by-pass valve on the vertical axis. Draw a horizontal line so that it intersects the Δp curve at a point. Read this point on the horizontal axis for the viscosity.

Mounting position

Preferably vertical, filter head on top

Connection

Threaded ports according to ISO 228 or DIN 13.
Sizes see Selection Chart, column 6 (other port threads on request).

Diagrams

Δp -curves for complete filters in Selection Chart, column 3

D1 Pressure drop as a function of the **flow volume**
at $v = 35 \text{ mm}^2/\text{s}$ (0 = casing empty)

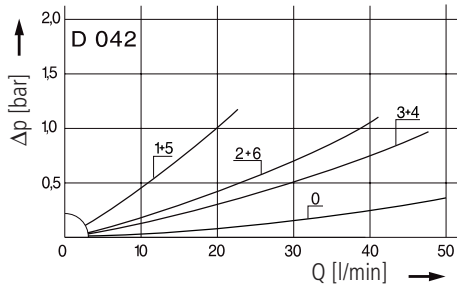

Pressure drop as a function of the **kinematic viscosity**
at nominal flow

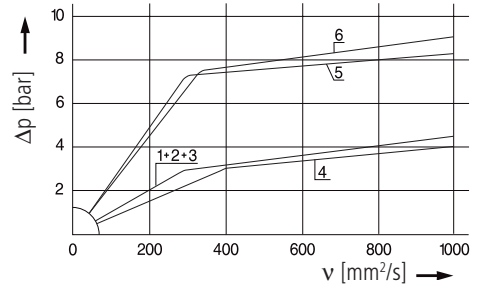

D2 Pressure drop as a function of the **flow volume**
at $v = 35 \text{ mm}^2/\text{s}$ (0 = casing empty)

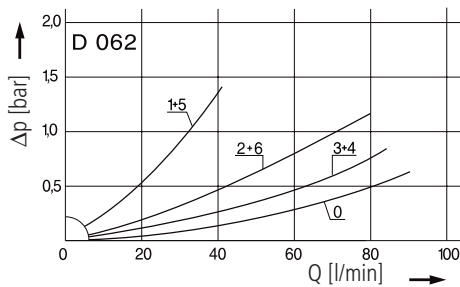

Pressure drop as a function of the **kinematic viscosity**
at nominal flow

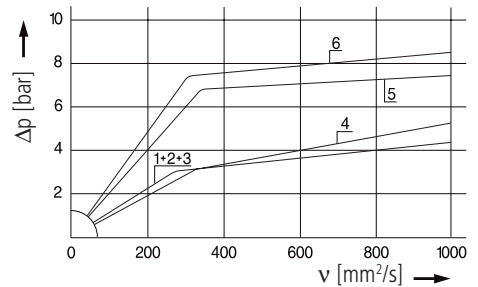

Filter fineness curves in Selection Chart, column 4

Dx Filtration ratio β as a function of particle size x obtained by the
Multi-Pass-Test according to ISO 16889

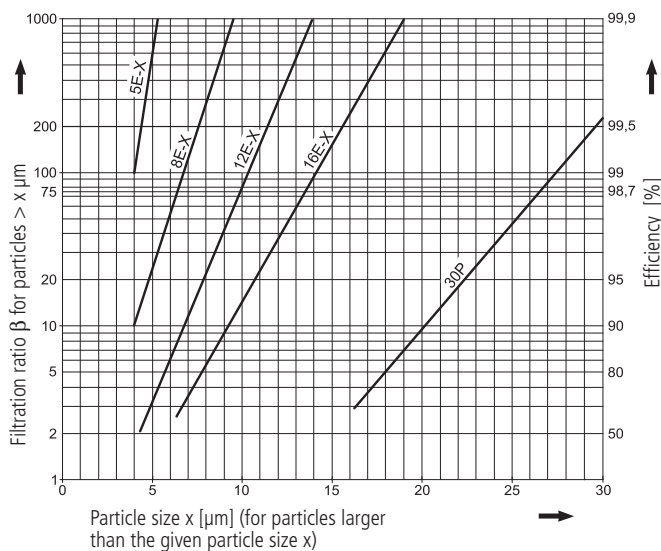

The abbreviations represent the following β -values resp. finenesses:

For EXAPOR[®]MAX- and Paper elements:

- 5 E-X** = $\bar{\beta}_{5(c)}$ = 200 EXAPOR[®]MAX
- 8 E-X** = $\bar{\beta}_{8(c)}$ = 200 EXAPOR[®]MAX
- 12 E-X** = $\bar{\beta}_{12(c)}$ = 200 EXAPOR[®]MAX
- 16 E-X** = $\bar{\beta}_{16(c)}$ = 200 EXAPOR[®]MAX
- 30 P** = $\bar{\beta}_{30(c)}$ = 200 Paper

Based on the structure of the filter media of the 30 P paper elements, deviations from the printed curves are quite probable.

For special applications, finenesses differing from these curves are also available by using special composed filter media.

Selection Chart

Part No.	Nominal flow	Pressure drop see diagram D /curve no.	Filter fineness see diagram Dx	Dirt-holding capacity	Connection A/B	Cracking pressure of by-pass	Symbol	Replacement filter element Part No.	Weight	Clogging indicator	Remarks		
1	l/min	2	3	4	g	5	6	7	8	9	10	11	12
D 042-153	9	D1/1	5 E-X	3,8	G½	3,5	4	V3.0510-03	0,8	optional	-		
D 042-156	15	D1/2	12 E-X	6,1	G½	3,5	4	V3.0510-06	0,8	optional	-		
D 042-158	30	D1/3	16 E-X	6,6	G½	3,5	4	V3.0510-08	0,8	optional	-		
D 042-151	35	D1/4	30 P	3,6	G½	3,5	4	P3.0510-11*	0,8	optional	-		
D 042-183	20	D1/5	5 E-X	3,8	G½	7	4	V3.0510-03	0,8	optional	-		
D 042-186	35	D1/6	12 E-X	6,1	G½	7	4	V3.0510-06	0,8	optional	-		
D 062-153	20	D2/1	5 E-X	7,6	G½	3,5	4	V3.0520-03	1,1	optional	-		
D 062-156	30	D2/2	12 E-X	13	G¾	3,5	4	V3.0520-06	1,1	optional	-		
D 062-158	60	D2/3	16 E-X	14	G¾	3,5	4	V3.0520-08	1,1	optional	-		
D 062-151	70	D2/4	30 P	7,1	G¾	3,5	4	P3.0520-01*	1,1	optional	-		
D 062-183	40	D2/5	5 E-X	7,6	G½	7	4	V3.0520-03	1,1	optional	-		
D 062-196	70	D2/6	12 E-X	13	G¾	7	4	V3.0520-06	1,1	optional	-		

Optical or electrical indicators are available to monitor the clogging condition of the element. If the indicator should be already mounted onto the filter head use the abbreviation "M" behind the part number of the indicator. The printed order acknowledgements show both items separately.

Order example: The filter D 042-156 has to be supplied with optical clogging indicator - response pressure 2,0 bar

Order description: D 042-156 / DG 042-01 M

Part No. (Basic unit) _____ **Mounted**

Clogging indicator _____

For the appropriate clogging indicators see catalogue sheet 60.30

Remarks:

- The switching pressure of the clogging indicator has always to be lower than the cracking pressure of the by-pass valve (see Selection Chart, column 7).
- The filters listed in this chart are standard filters. Other designs available on request.

* Paper media supported with metal gauze

Dimensions

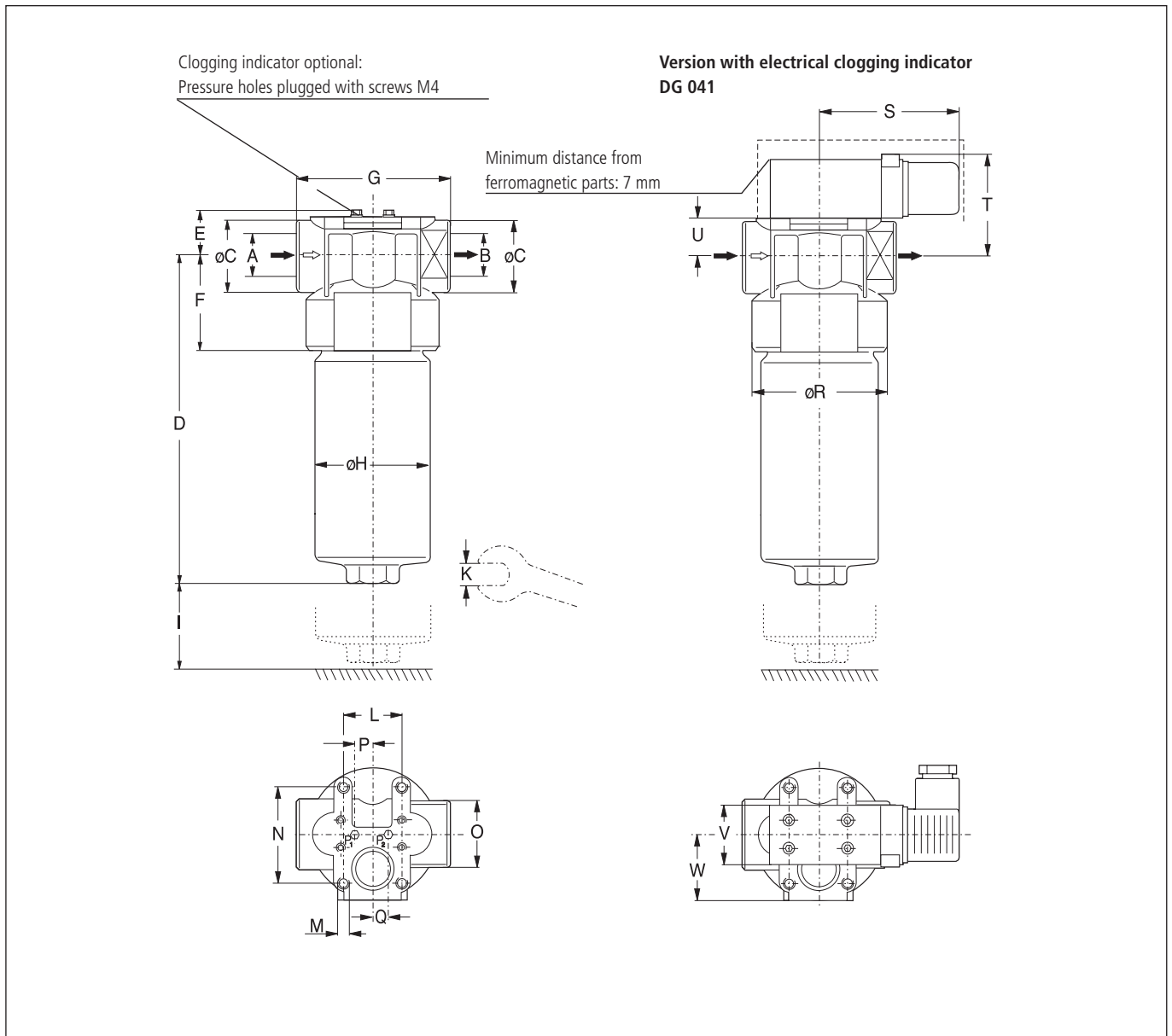

Measurements

Type	A/B	C	D	E	F	G	H	I	K	L	M ø/depth	N	O	P	Q	R	S	T	U	V	W
D 042	G $\frac{1}{2}$	39	148	27	45,5	80	58,5	55	27	35	M6/8	44	36	19	15	70	81	55	23	30	35,5
D 062	G $\frac{1}{2}$, G $\frac{3}{4}$	39	244	27	45,5	80	58,5	55	27	35	M6/8	44	36	19	15	70	81	55	23	30	35,5

Symbols

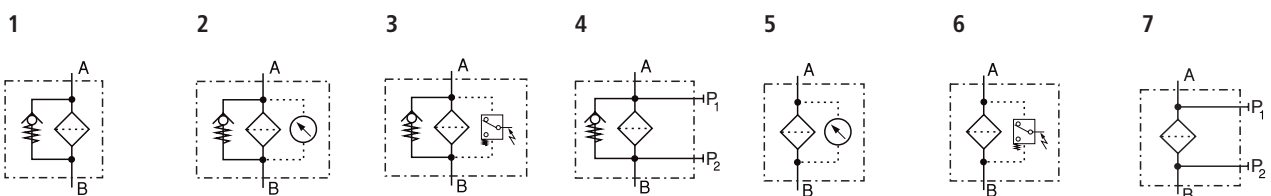

Spare Parts

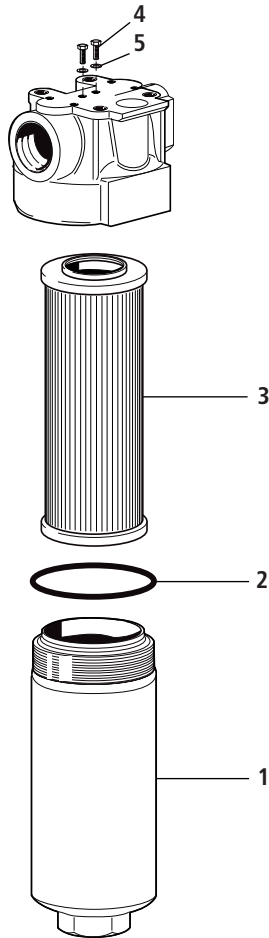

Pos.	Designation	Part No.
1	Filter bowl D 042	D 044.0101
1	Filter bowl D 062	D 064.0101
2	O-ring 50 x 2	N 007.0501
3	Filter element (with seal)	see Chart / col. 9
4	Hexagonal head screw M4 x 8 DIN 933-8.8	3301051
5	Bonded seal 4,1 x 7,2 x 1	3404074

The functions of the complete filters as well as the outstanding features of the filter elements assured by ARGO-HYTOS can only be guaranteed if original ARGO-HYTOS spare parts are used.

Quality Assurance

Quality management according to DIN EN ISO 9001

To ensure constant quality in production and operation, ARGO-HYTOS filter elements undergo strict controls and tests according to the following DIN and ISO standards:

DIN ISO 2941	Verification of collapse/burst resistance
DIN ISO 2943	Verification of material compatibility with fluids
DIN ISO 3724	Verification of flow fatigue characteristics

ISO 2942 ISO 3968 ISO 16889

Verification of fabrication integrity (Bubble Point Test)
Evaluation of pressure drop versus flow characteristics
Multi-Pass-Test (evaluation of filter fineness and dirt-holding capacity)

Before release into the series production the filter casing is tested for fatigue strength in our pressure pulse test rig. Various quality controls during the production process guarantee the leakfree function and solidity of our filters.

Our engineers will be glad to advice you in questions concerning filter application, selection as well as the cleanliness class of the filtered medium attainable under practical operating conditions.

Illustrations may sometimes differ from the original. ARGO-HYTOS is not responsible for any unintentional mistake in this specification sheet.



We produce fluid power solutions

ARGO-HYTOS GMBH · Industriestraße 9 · D-76703 Kraichtal

Tel: +49 7250 76-0 · Fax: +49 7250 76-199 · info.de@argo-hytos.com · www.argo-hytos.com